

Single Phase Induction Motor

Single Phase Induction Motor

- The single-phase induction machine is the most frequently used motor for refrigerators, washing machines, clocks, drills, compressors, pumps, and so forth.
- The single-phase motor stator has a laminated iron core with two windings arranged perpendicularly.
 - One is the main and
 - The other is the auxiliary winding or *starting winding*

Single Phase Induction Motor

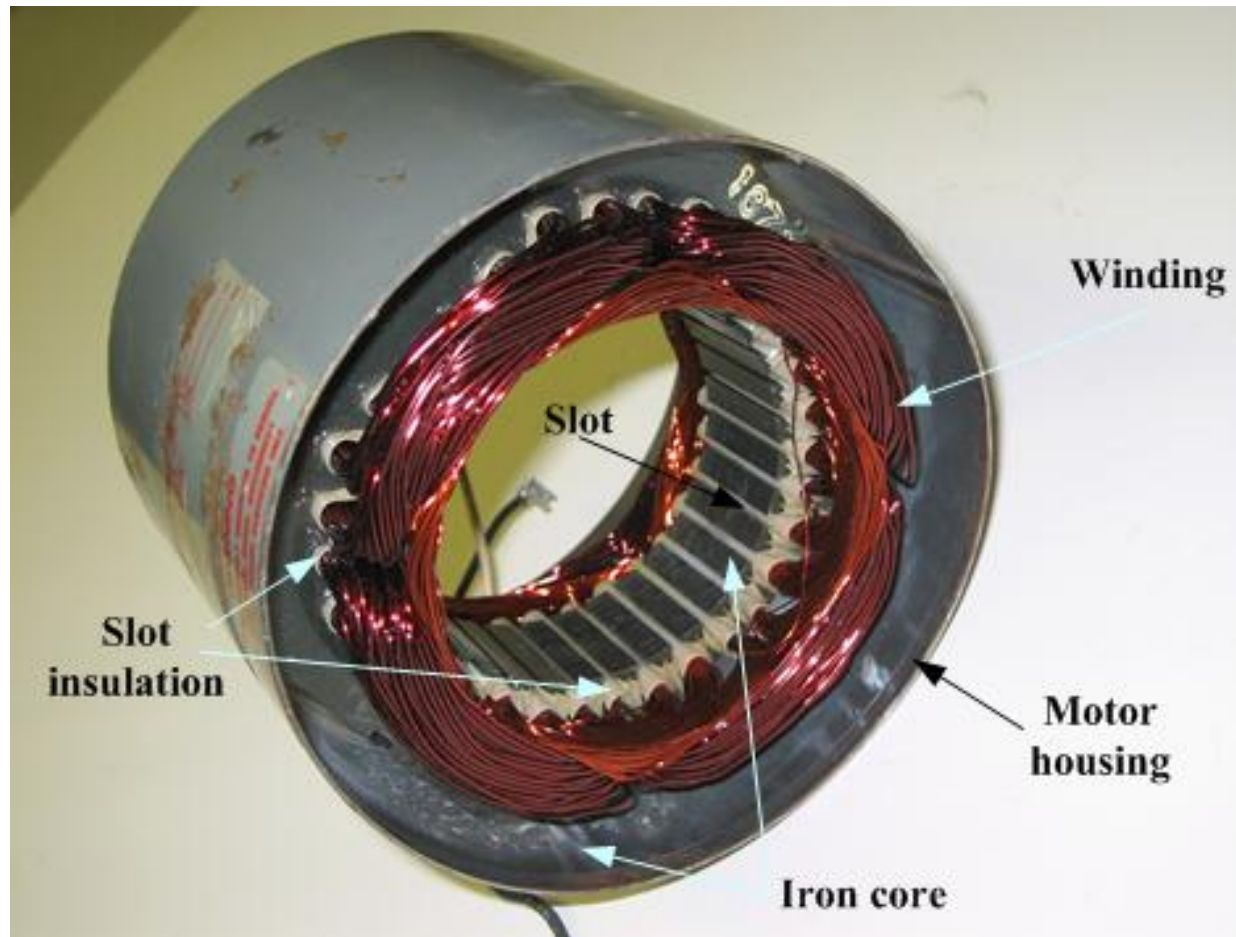

Single Phase Induction Motor

- This “single-phase” motors are truly two-phase machines.
- The motor uses a squirrel cage rotor, which has a laminated iron core with slots.
- Aluminum bars are molded on the slots and short-circuited at both ends with a ring.

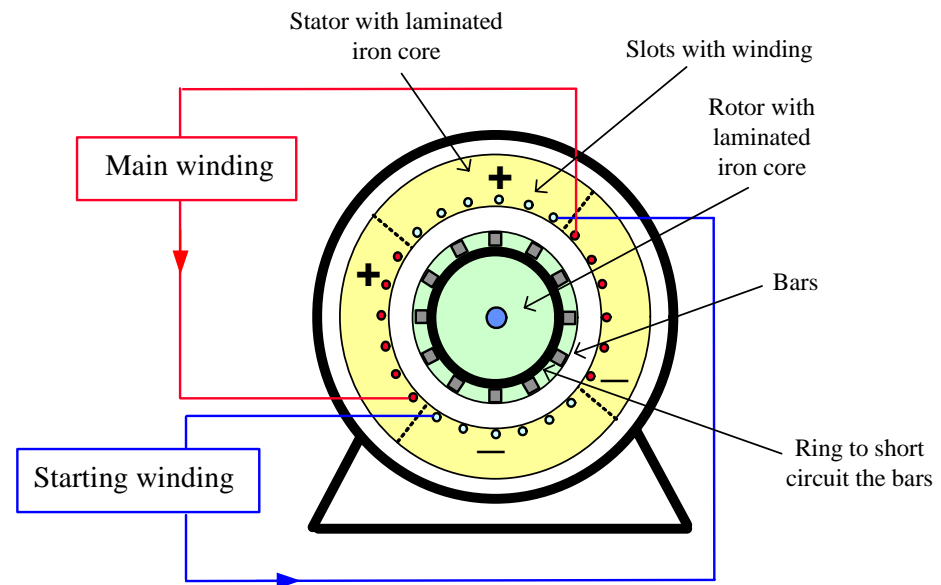

Figure 42 Single-phase induction motor.

Single Phase Induction Motor

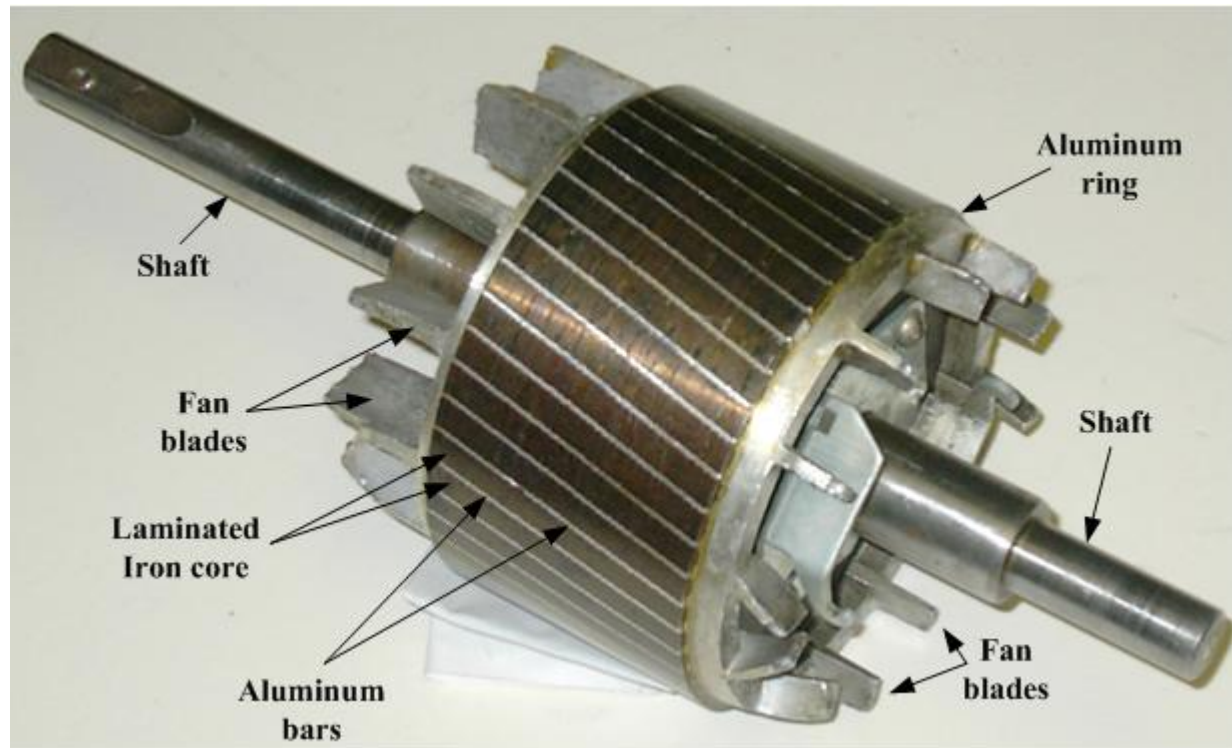

Figure 10 Squirrel cage rotor

Operating principle

Single Phase Induction Motor

- **The single-phase induction motor operation can be described by two methods:**
 - **Double revolving field theory; and**
 - **Cross-field theory.**
- **Double revolving theory is perhaps the easier of the two explanations to understand**
- **Learn the double revolving theory only**

Single Phase Induction Motor

Double revolving field theory

- **A single-phase ac current supplies the main winding that produces a pulsating magnetic field.**
- **Mathematically, the pulsating field could be divided into two fields, which are rotating in opposite directions.**
- **The interaction between the fields and the current induced in the rotor bars generates opposing torque**

Single Phase Induction Motor

- **The interaction between the fields and the current induced in the rotor bars generates opposing torque.**
- **Under these conditions, with only the main field energized the motor will not start**
- **However, if an external torque moves the motor in any direction, the motor will begin to rotate.**

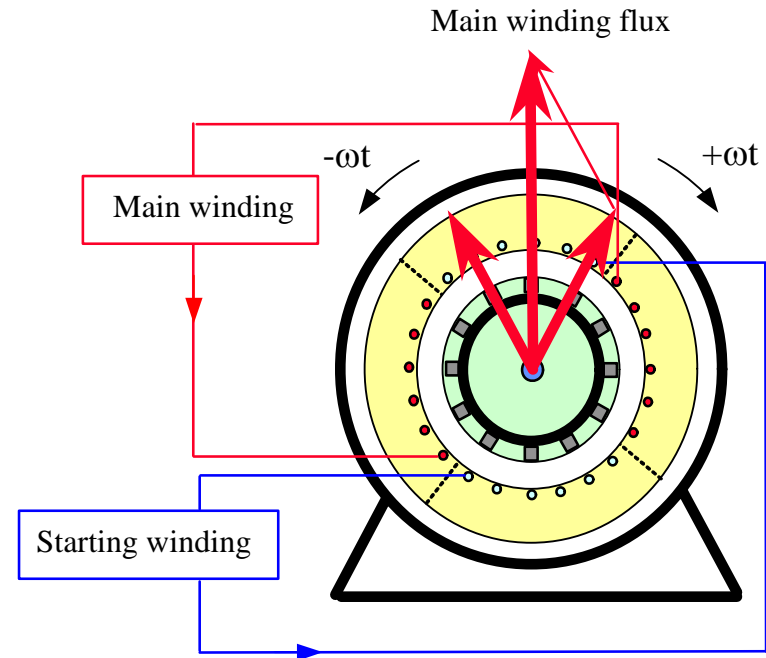

Figure 43 Single-phase motor main winding generates two rotating fields, which oppose and counter-balance one another.

Single Phase Induction Motor

Double revolving field theory

- The pulsating field is divided a forward and reverse rotating field
- Motor is started in the direction of forward rotating field this generates small (5%) positive slip

$$s_{pos} = (n_{sy} - n_m) / n_{sy}$$

- Reverse rotating field generates a larger (1.95%) negative slip

$$s_{neg} = (n_{sy} + n_m) / n_{sy}$$

Single Phase Induction Motor

Double revolving field theory

- **The three-phase induction motor starting torque inversely depends on the slip**

$$T_{m_start}(s) := \frac{3 \cdot \left(|I_{rot_t}(s)| \right)^2 \cdot \frac{R_{rot_t}}{s}}{2 \cdot \pi \cdot n_{sy}}$$

- **This implies that a small positive slip (0.01–0.03) generates larger torque than a larger negative slip (1.95–1.99)**
- **This torque difference drives the motor continues to rotate in a forward direction without any external torque.**

Single Phase Induction Motor

Double revolving field theory

- **Each of the rotating fields induces a voltage in the rotor, which drives current and produces torque.**
- **An equivalent circuit, similar to the equivalent circuit of a three phase motor, can represent each field**
- **The parameters of the two circuits are the same with the exception of the slip.**

Single Phase Induction Motor

Double revolving field theory

- **The two equivalent circuits are connected in series.**
- **Figure 44 shows the equivalent circuit of a single-phase motor in running condition.**
- **The current, power and torque can be calculated from the combined equivalent circuit using the Ohm Law**
- **The calculations are demonstrated on a numerical example**

Single Phase Induction Motor

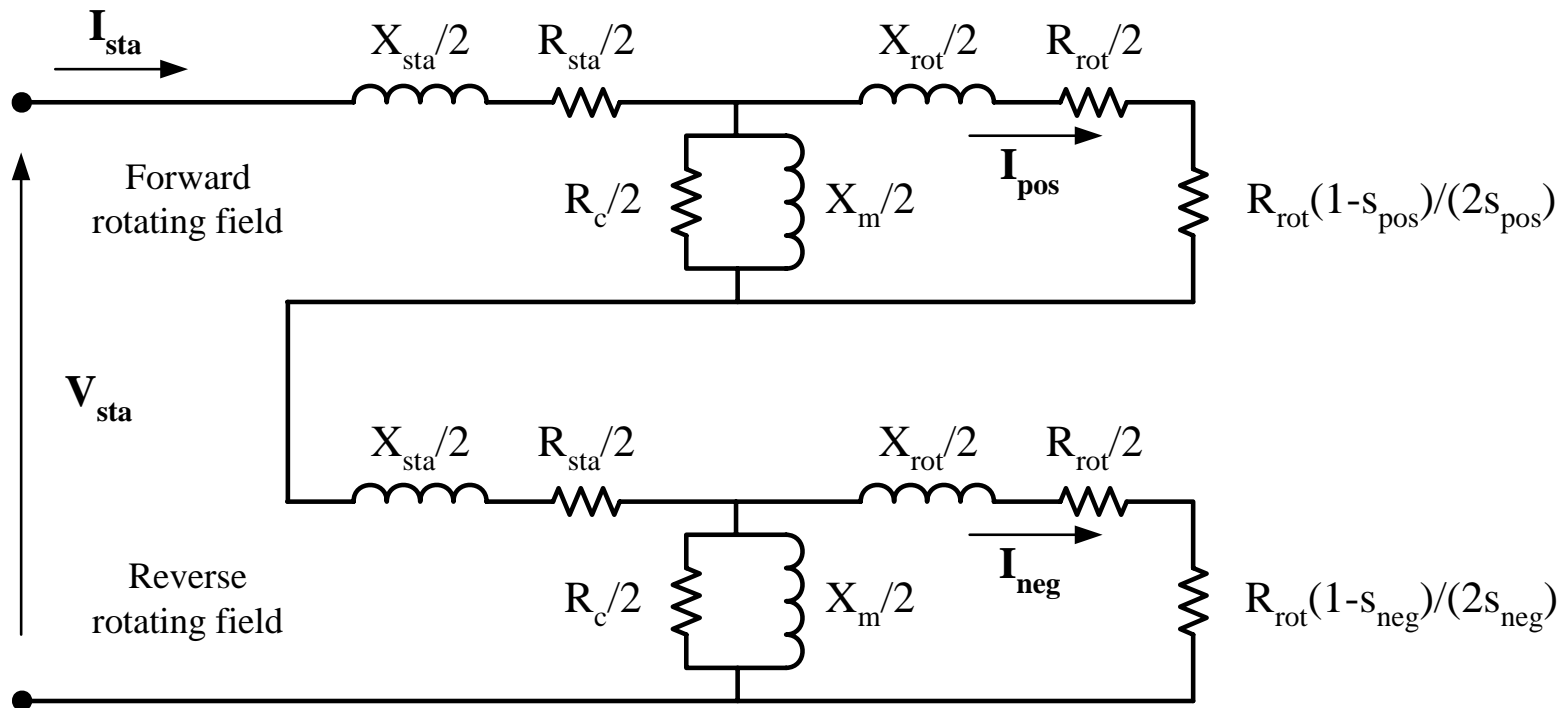

Figure 44 Equivalent circuit of a single-phase motor in running condition.

Single Phase Induction Motor

The results of the calculations are:

– Input power:

$$\mathbf{S}_{in} = \mathbf{V}_{sta} \mathbf{I}_{sta}^*$$

– Developed or output power:

$$P_{dev} = \left| \mathbf{I}_{pos} \right|^2 \frac{R_{rot}}{2} \frac{1 - s_{pos}}{s_{pos}} + \left| \mathbf{I}_{neg} \right|^2 \frac{R_{rot}}{2} \frac{1 - s_{neg}}{s_{neg}}$$

Single Phase Induction Motor

$n_m := 400\text{rpm} , 410\text{rpm} .. 1780\text{rpm}$

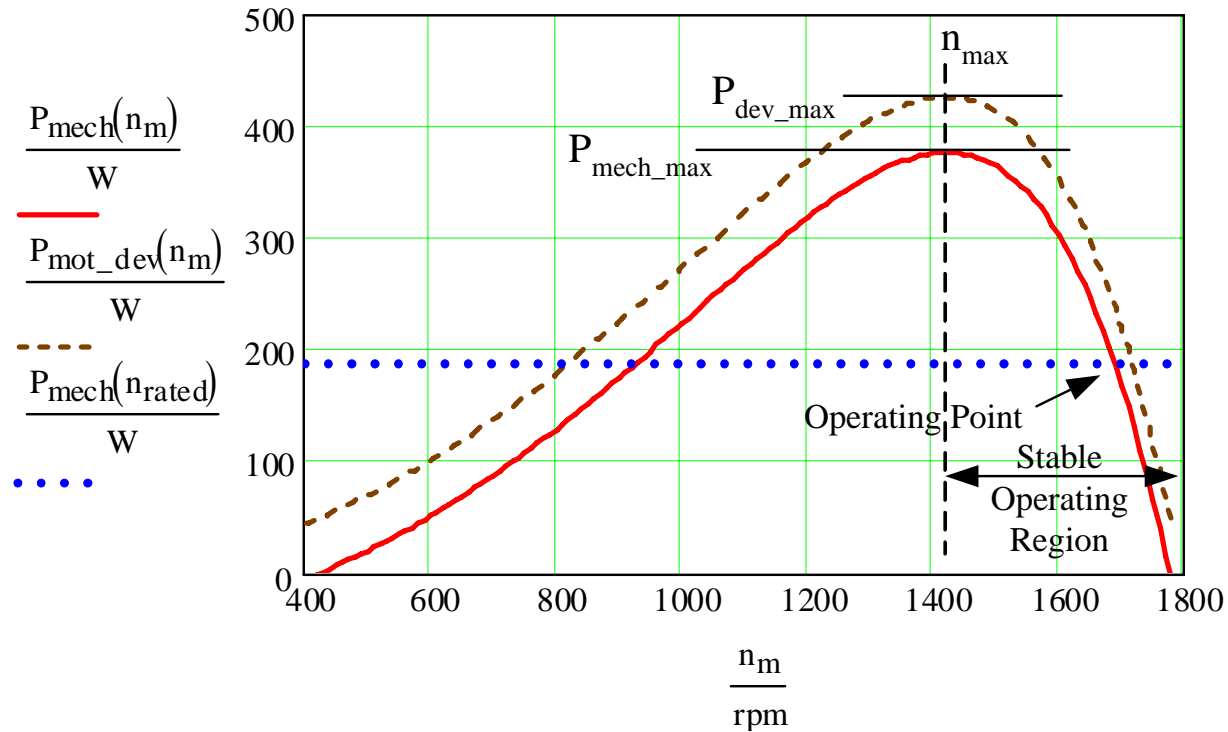

Figure 47 Single-phase motor mechanical output power and electrically developed power versus speed.

Starting torque

Single Phase Induction Motor

- **The single-phase motor starting torque is zero because of the pulsating single-phase magnetic flux.**
- **The starting of the motor requires the generation of a rotating magnetic flux similar to the rotating flux in a three-phase motor.**
- **Two perpendicular coils that have currents 90° out-of-phase can generate the necessary rotating magnetic fields which start the motor.**
- **Therefore, single-phase motors are built with two perpendicular windings.**

Single Phase Induction Motor

- **The phase shift is achieved by connecting**
 - a resistance,
 - an inductance, or
 - a capacitance
- in series with the starting winding.**
- **Most frequently used is a capacitor to generate the starting torque.**

Single Phase Induction Motor

- **Figure 50 shows the connection diagram of a motor using a capacitor to generate the starting torque.**
- **When the motor reaches the operating speed, a centrifugal switch turns off the starting winding.**

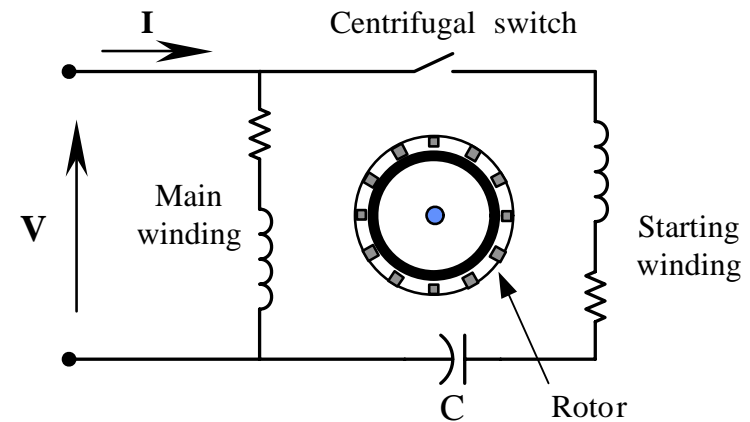

Figure 50 Single-phase motor connection.

Single Phase Induction Motor

- The centrifugal switch is necessary because most motors use a cheap electrolytic capacitor that can only carry ac current for a short period.
- A properly selected capacitor produces around 90° phase shift and large starting torque.

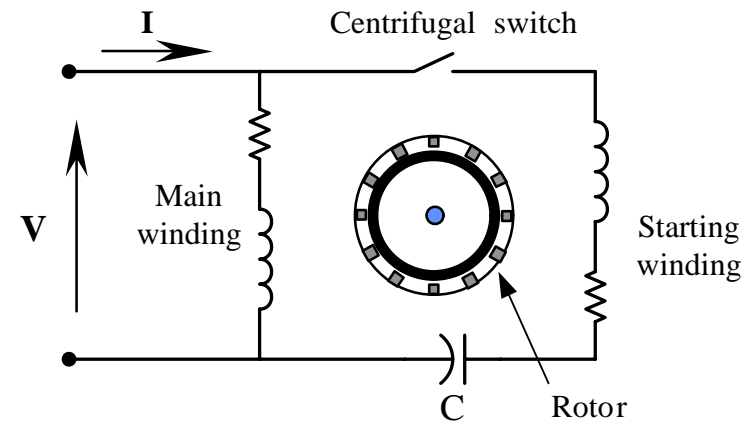

Figure 50 Single-phase motor connection.

Single Phase Induction Motor

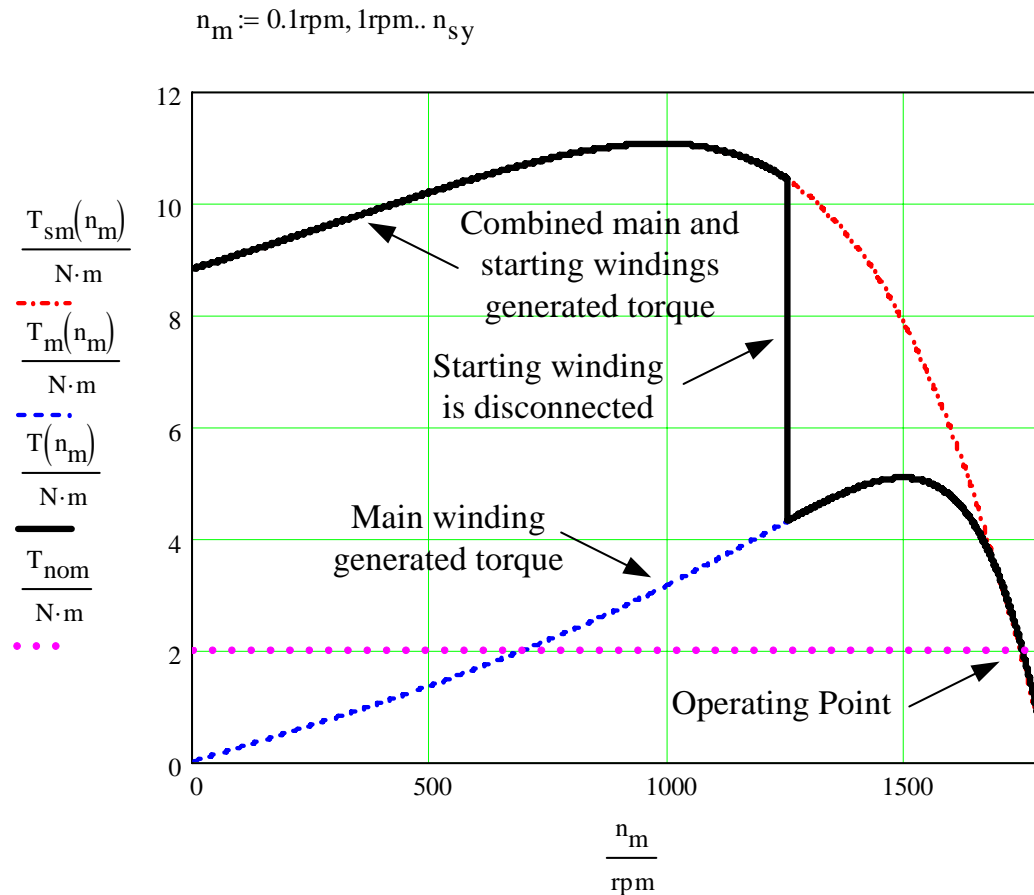

Figure 51
Torque–speed
characteristic of
a small single-
phase induction
motor.

Single Phase Induction Motor

- **A less effective but more economical method using shaded pole motors**
- **The motor has two salient poles excited by ac current.**
- **Each pole includes a small portion that has a short-circuited winding. This part of the pole is called the shaded pole.**
- **The main winding produces a pulsating flux that links with the squirrel cage rotor.**
- **This flux induces a voltage in the shorted winding.**

Single Phase Induction Motor

- **The induced voltage produces a current in the shorted winding.**
- **This current generates a flux that opposes the main flux in the shaded pole (the part of the pole that carries the shorted winding).**
- **The result is that the flux in the unshaded and shaded parts of the pole will be unequal.**
- **Both the amplitude and the phase angle will be different.**

Single Phase Induction Motor

- **These two fluxes generate an unbalanced rotating field. The field amplitude changes as it rotates.**
- **Nevertheless this rotating field produces a torque, which starts the motor in the direction of the shaded pole.**
- **The starting torque is small but sufficient for fans and other household equipment requiring small starting torque.**
- **The motor efficiency is poor but it is cheap**

Single Phase Induction Motor

- The motor has two salient poles excited by ac current.
- Each pole includes a small portion that has a short-circuited winding.
- This part of the pole is called the shaded pole

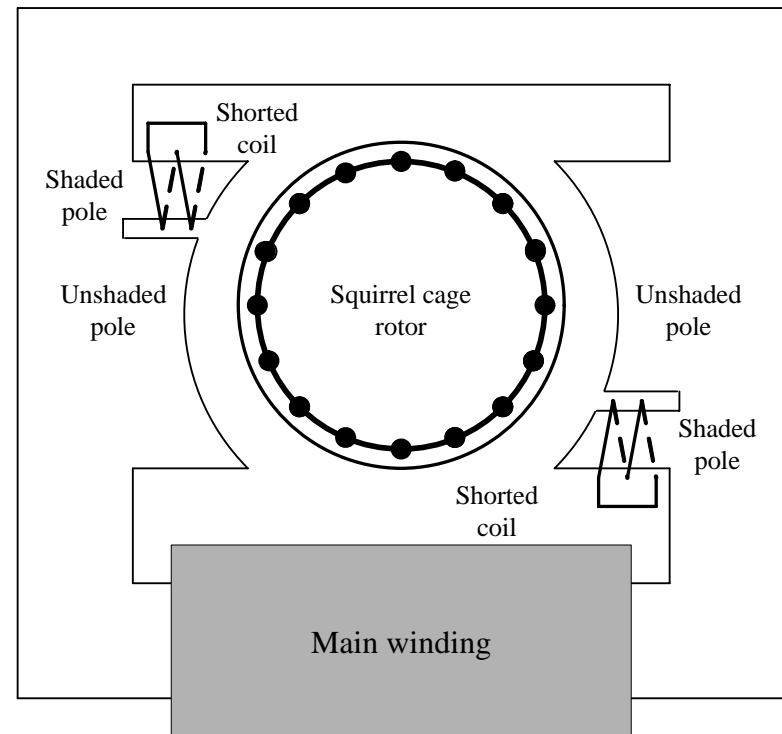

Figure 52 Concept of single-phase shaded pole motor.

Single Phase Induction Motor

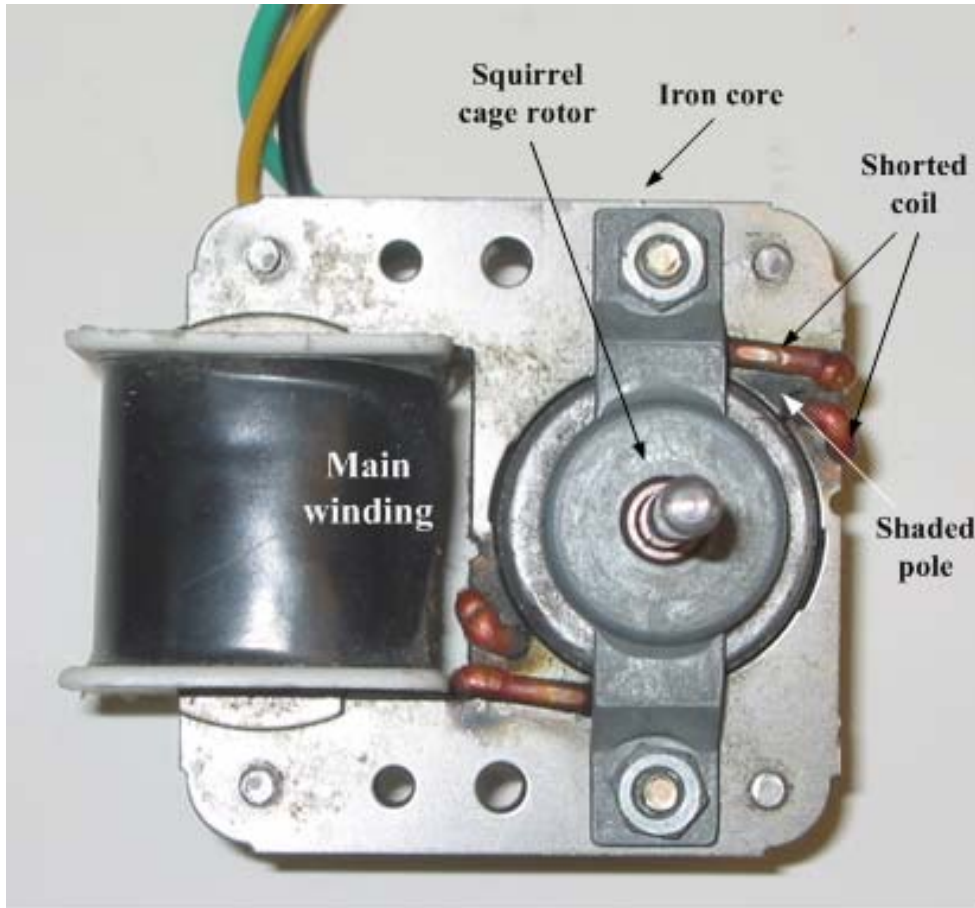

Figure 53
Shaded pole
motor for
household fan.